



PROLEĆNI BILTEN



April 2013





ELIPSASTA ŽARDINJERA
119x59cm, h=42cm



ELIPSASTA ŽARDINJERA
80x44cm, h=42cm



ELIPSASTA SAKSIJA
60x21cm, h=20cm
80x25,5cm, h=26cm



ŽARDINJERA SA NOGICAMA
105x35cm, h=55cm



OKRUGLA ŽARDINJERA
fi 59cm, h=42cm



PEHARASTA ŽARDINJERA
75x23cm, h=46cm



KONUSNA ŽARDINJERA
100x55cm, h=45cm



ČETVRTASTA ŽARDINJERA
57x57cm, h=53cm



BETONSKA ŽARDINJERA
60x60cm, h=85cm



SANDUČASTA ŽARDINJERA
100x45cm, h=55cm



POTPORNA ŽARDINJERA
30x30cm, h=13cm



URBANI MOBILIJAR

ŽARDINJERE

Betonske žardinjere za cveće pogodne za bašte, ulice, trgove, kafiće, restorane, firme...

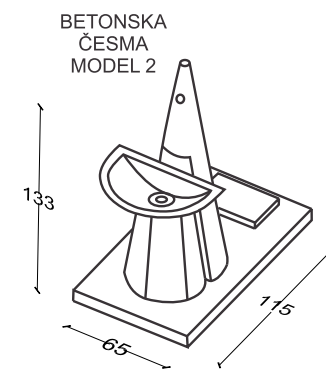
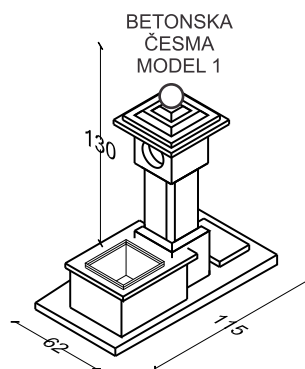
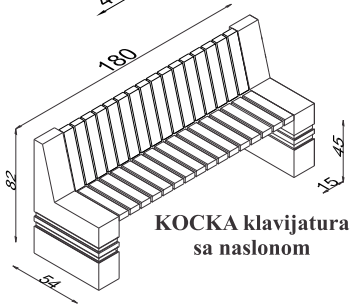
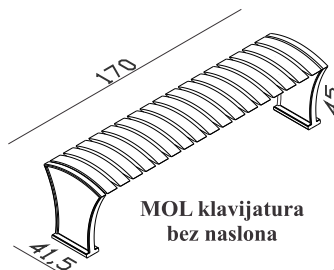
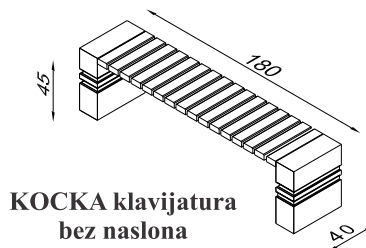
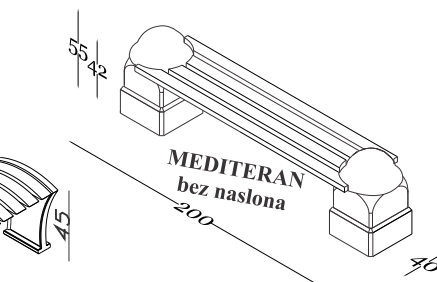
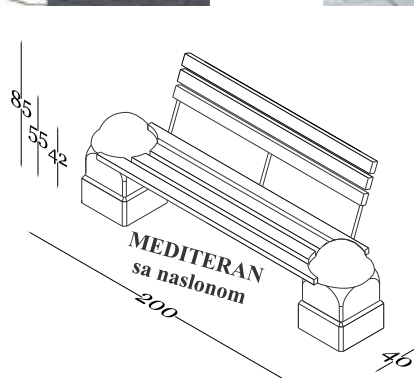

BETONSKI
STALAK
ZA
BICIKLE

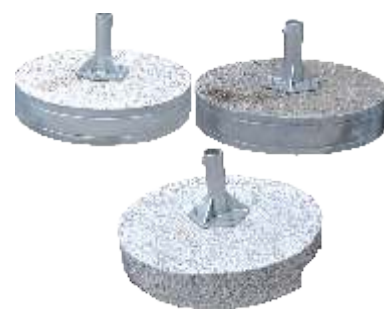

POSTOLJA ZA SUNCOBRAŃE

1



BETONSKA KANTA K
Φ 50 cm, h=80cm

2



BETONSKA KANTA K 4
45x45cm, h=70cm

3



BETONSKA KANTA SA KLAPNOM K5
donje mere 51x51cm, gornje mere 60x60cm, h=85cm

4



BETONSKA KANTA K1
Φ 58cm, h=115cm

5



BETONSKA KANTA K2
Φ 40cm, h=86,5cm

6



BETONSKA MALA KANTA K3
31cm, h=80cm



7



8



9

BETONSKE KANTE

URBANI MOBILIJAR

1



ZAŠTITNI STUB 1
fi 50cm, h=110cm

2



ZAŠTITNI STUB 2
fi 24cm, h=44,5cm

3

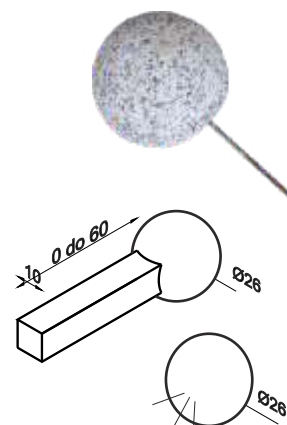

ZAŠTITNA KUGLA

4



ZAŠTITNI STUB 4
16x16cm, h=45cm

5



ZAŠTITNI STUB 5
40x40cm, h=88cm

6



DVODELNI ZAŠTITNI STUB
40x40cm, h=36cm

7



TRODELNI ZAŠTITNI STUB
40x40cm, h=55cm



8

9



10



11



BAZENSKI RUBNI KAMEN

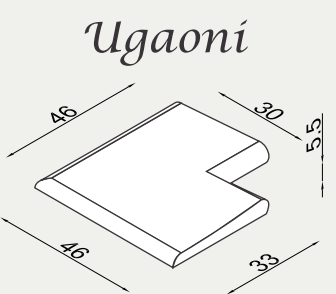
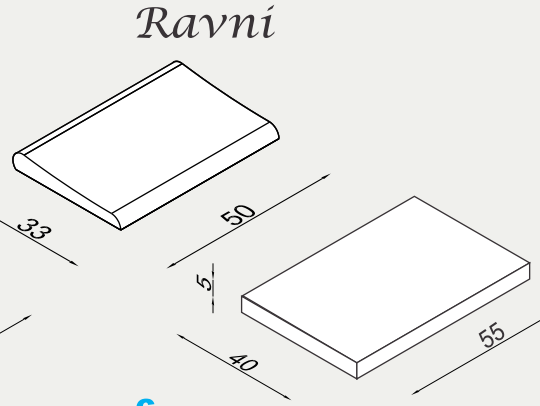
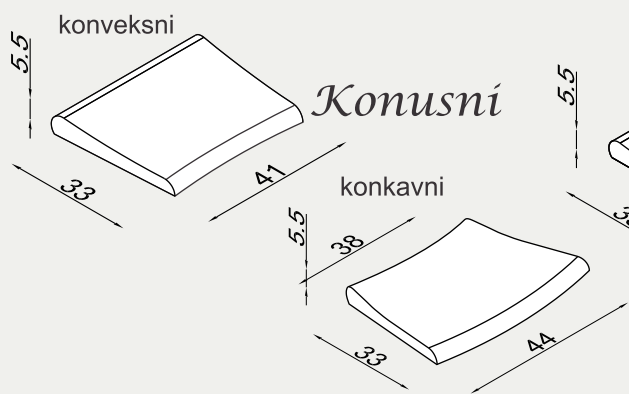





PLAČE



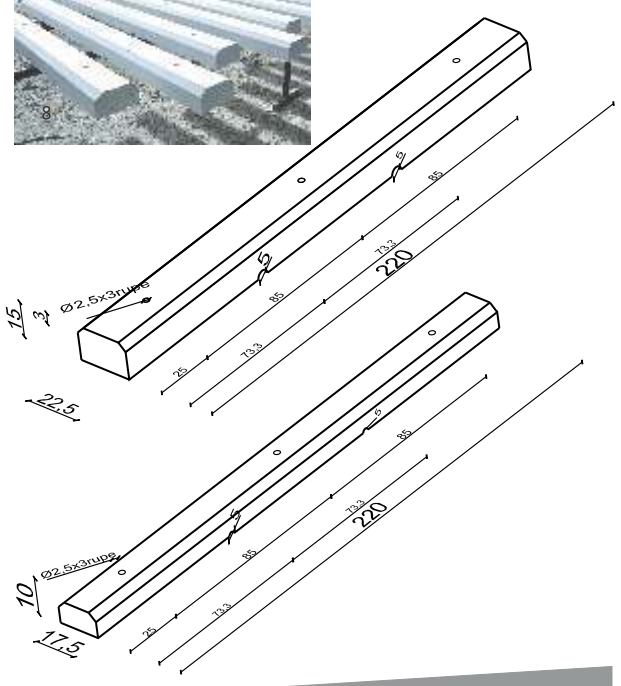
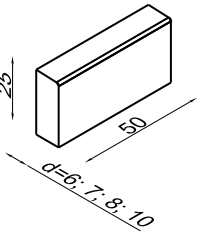
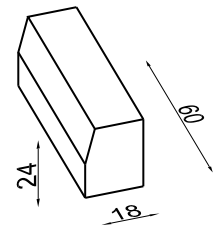
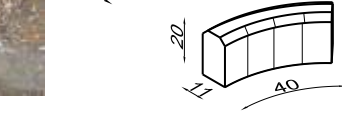
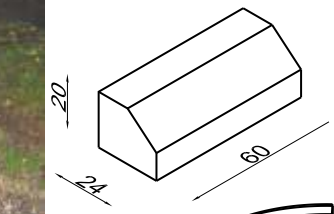
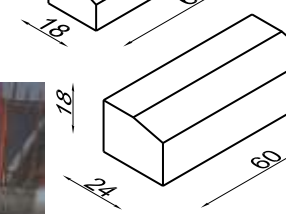
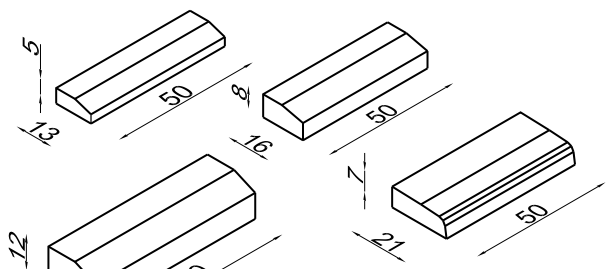
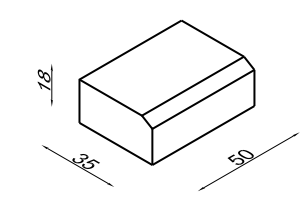
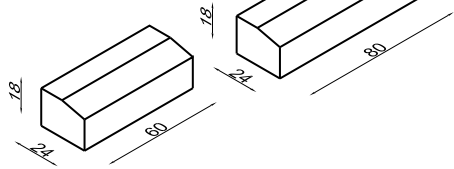
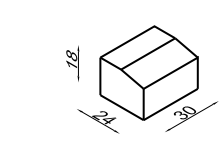
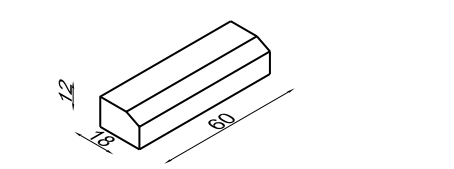
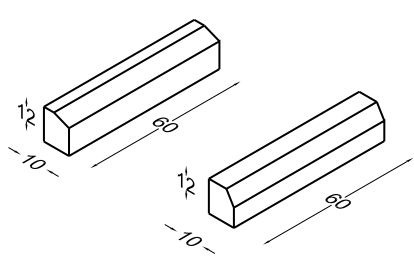
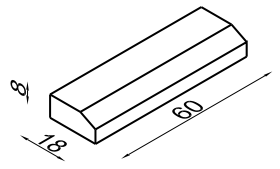
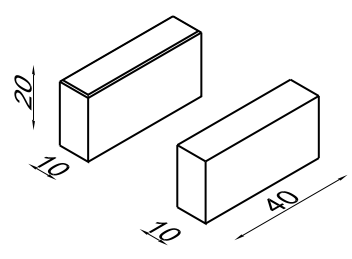
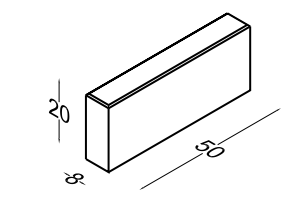
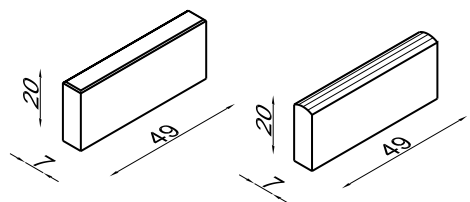

IVICNJACI

Ivičnjaci za pešačke zone, staze, parkinge, vrtove, travnjake, putarski ivičnjaci, granični ivičnjaci za vozila...

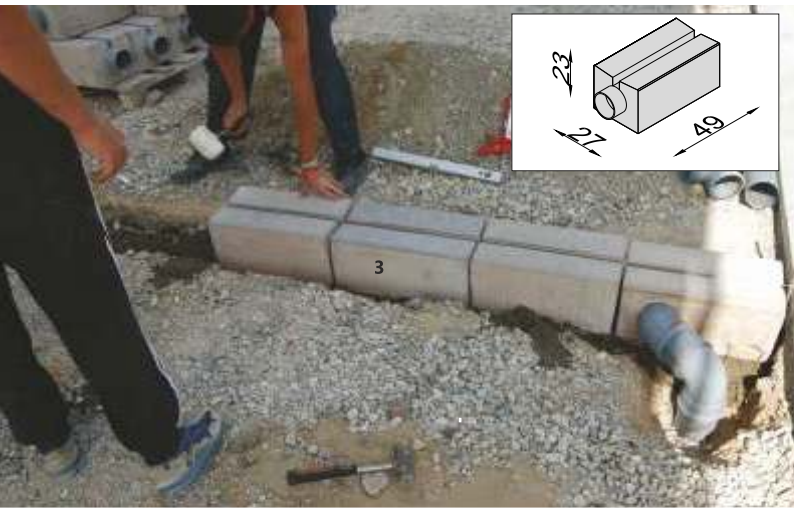

KANALETE

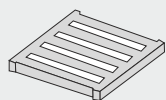
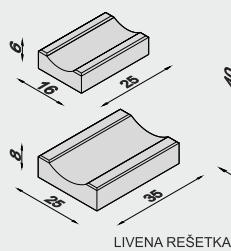

45/39/6



GAJGER SLIVNIK
Za preliv i taloženje
atmosferske
kanalizacije.
Sa čeličnom
rešetkom.

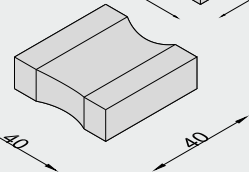
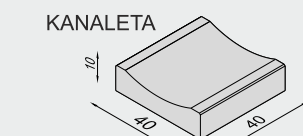
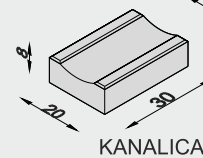
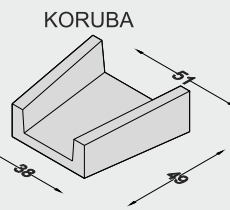
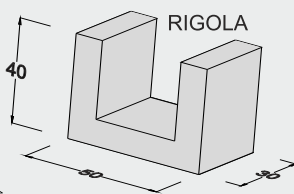
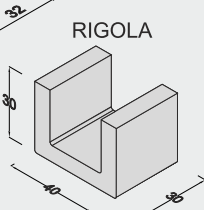
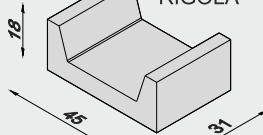
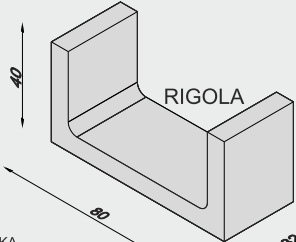

ROŠTILJI



PERA 60

GABARIT: 70/120/230
TEŽINA: 450kg



ERA 90

GABARIT: 80/160/280
TEŽINA: 900kg



Era 130



Era 130



ERA 130

GABARIT: 100/180/270
TEŽINA: 1250kg



Era 200 i pećnica



Pera 60



PERA 50

GABARIT: 110/60/210
TEŽINA: 600kg



ERA 200

GABARIT: 180/100/270
TEŽINA: 2000kg



Era 200



Era 130



Roštilji po zahtevu





GRAĐEVINSKE MAŠINE IZNAJMLJIVANJE I PRODAJA

Valjci, vibro ploče, vibro igle, vibro letve, vibro motori, helikopteri, mašine za rezanje betona, kalupi za probne kocke, mehanički sečko, tamperni, kompresori, mašine za mašinsko malterisanje...

Sva oprema za obradu betona i ugradnju prefabrikovanih betonskih elemenata za niskogradnju i visokogradnju.

tel/fax: +381 21 462 255

mob: +381 62 6000 64

office@tiha-beton.rs

www.tiha-beton.rs



VIBRO PLOČE
VELIKI IZBOR VIBRO PLOČA
80-600kg
RENOMIRANIH SVETSKIH
PROIZVOĐAČA
BOMAG, WACKER,
AMMANN...



HELIKOPTERI ZA BETON



VIBRO LETVE



VIBRO IGLE



KOMPRESORI



MAŠINA ZA MALTERISANJE
PUTZMEISTER



MINI UTOVARIVAČ
VEPER
Kašika kapacitet 0,3m³,
mešalica za mini utovarivač,
vile...



UTOVARIVAČ
sa okretnom kašikom

Kašika 0,9m³
Širina kašike 2m

Viljuške do 2t tereta
Čekići za razbijanje-pikamer



VILJUŠKARI

- Prodaja viljuškara
- Iznajmljivanje viljuškara
- Prodaja rezervnih delova
- Proizvodnja i prodaja utovarnih kašika (više tipova kašika sa istovarnim klipom na hidrauliku, projektovane za transport i manipulaciju rastresitih građevinskih materijala, žitarica, po neravnim terenima, kapaciteti kašika-po zahtevu).
- Korpe za viljuškar za bezbedno dizanje ljudi na visinu
- Horizontalne mešalice za viljuškar



DIZALICE ZA SILOSE

Projektujemo, proizvodimo, prodajemo i ugrađujemo dizalice za različite namene, visine, težine tereta.

Dizalice za silose za žitarice, industrijske objekte i ostale objekte za rad na visini, dizalice dižu 200kg na 40m visine.

Atestirane dizalice sa svom pratećom dokumentacijom. Proizvodnja, ugradnja, održavanje i remont.



021462-255

**PROLEĆNI
BILTEN**

Izdavač: doo Tiha
Cara Lazara 15
Sremska Kamenica
tel./fax +381 21 462 255
e-mail: doo.tiha@gmail.com

Uređuje redakcijski kolegijum:

Siniša Obradović
Lazar Obradović

Dizajn:

Vladimir Stanković

Bilten izlazi dva puta godišnje.

Besplatan primerak

ROŠTILJI

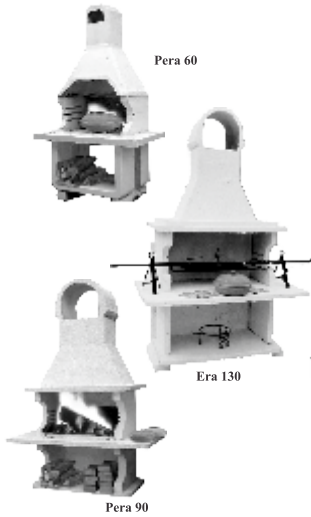

Pera 60





















Era 130

Pera 90









Moguće su greške u preprijeti kataloga.
Pojedine slike su približne i služe za brže
identifikovanje pojedinih proizvoda.







PRESOVANI PROGRAM **Beton ploče:**

BEHATON  16,4/20/6-8cm POTROŠNJA-35 kom/m ²	OLIMPIJA  16,5/24,5/6cm POTROŠNJA-40 kom/m ²	REKET  22/13/6cm POTROŠNJA-38 kom/m ²	DELTOID  29/17/6 cm POTROŠNJA-42 kom/m ²	LEPEZA  21,5/16/6-8cm POTROŠNJA-41 kom/m ²	BAROK+  22/26/6-8cm POTROŠNJA-28 kom/m ²	MEBA  60/40/10cm POTROŠNJA-4kom/m ²
RUSTIK  28/21/6 21/14/6 14/14/6 7/14/6	CIGLA  10,5/21cm POTROŠNJA-45 kom/m ²	SAĆE  MALO-18,5/16cm POTROŠNJA-44 kom/m ²	SAĆE  VELIKO-23,5/20,5cm POTROŠNJA-27 kom/m ²	VENECIJA  20/20/6-8cm POTROŠNJA-25 kom/m ²	TRAPEZ  34/15/6-8cm POTROŠNJA-26 kom/m ²	PLOČE  40/40/6-8cm 30/30/6-8cm 20/20/6-8cm 10/10/6-8cm
PLOČE ZA SLEPE  40/40/6-8cm 30/30/6-8cm	PLETENICA  16,4/20/6-8cm 20/20/6-8cm	BLOK ZA UREĐENJE  30/30/40 30/20/28 20/30/18/6	OBALA  20/20/40 cm	PLOČA  50/50/6 cm	ŠVEDSKI SLOG 	VELIKI BEHATON  10,5/21 cm POTROŠNJA-43 kom/m ²







Kanalete:

Kanalic  20/30/8cm	Kanalet  40/40/10cm	Rigola  45/30/18cm	Rigola  40/30/30	Rigola  50/40/30	Rigola  80/32/40
--	---	--	---	--	--























Ivičnjaci:

Koruba  51/49/38	 10/19/40cm	 8/18/60	 12/18/60	 18/24/30	 18/24/60	 18/24/80
--	---	--	---	---	---	---







BETONSKI ELEMENTI ZA ŽARDINJERE

 40/40/48/30/8cm	 40/20/30/8cm	 40/50/30/8cm	 15/50/30/8cm	 18/35/50	 Ležeći policajac 30/30/12cm	 18/24/80
---	--	--	--	--	--	--







LIVENI PROGRAM **Beton ploče:**

BEHATON  16,4/20/6-8cm POTROŠNJA-35 kom/m ²	HRAPAVI GLATKA KOST  22/13,5/2,5-4-6cm POTROŠNJA-41 kom/m ²	SAĆE  18,5/16/2,5-4-6cm POTROŠNJA-42 kom/m ²	SAĆE III-a  Potrošnja 18/18/2,5-4-6cm 44 kom/m ²	LEPEZA  24/17 d=6/4/2,5 cm POTROŠNJA-32 kom/m ²	BAROK  22/26/6-8cm POTROŠNJA-28 kom/m ²	MOZAIK  d=6/4/2,5 cm POTROŠNJA-33 kom/m ²	RASTER  26/26 d=6/4 cm POTROŠNJA-14,5 kom/m ²
BUNJA  25/25 d=2,5 cm POTROŠNJA-16 kom/m ²	ČOKOLADA  25/25 d=6 cm POTROŠNJA-16 kom/m ²	KOCKICA  30/30 d=4,5 cm POTROŠNJA-11 kom/m ²	SUNCE  30/30 d=4,5 cm POTROŠNJA-11 kom/m ²	 40/40 d=5 cm POTROŠNJA-6 kom/m ²	HRAPAVI GLATKA CIGLA  15/15 d=3cm 5/5/3	 10,5/21 cm POTROŠNJA-50 kom/m ²	
KRUG NIŠ 	DASKA  43/14/3 cm	PLOČA  50/50/5 POTROŠNJA-4 kom/m ²	DUNAV PLOČE  40/25/20	 50/50/10 cm	 178/66/15 cm	 GAJGER SLIVNIK	





Kanalet i rešetke:

 25/35/8	 16/25/6	 27/49/23	KANALETE ZA TEŠKI SAOBRAĆAJ  180/100/65 cm 207/100/65 cm	KANALETE  70/100/65 cm	LIVENA REŠETKA  armatura-ø6 III ø10 45/59/6	REŠETKE ZA STAJE ZA SVINJE I GOVEDA 
--	--	---	---	--	--	---





Ivičnjaci:

 12/18/60cm	 18/24/60cm	 20/24/60cm	 5/13/50cm	 8/16/50cm	GRANIČNI ZAUSTAVNI IVIČNJIACI ZA VOZILA  220/22,5/15	 220/17,5/10
---	---	---	---	--	--	--



Čela i gazišta:

 GAZIŠTE-125/33/5 ČELO-125/15/3	 33/27/2cm	 25/17/2	 33/17/2
---	--	--	--

Bazenski rubni kamen:

konveksni  41/33/5,5	konkavni  44/38/33/5,5	Ravni  50/33/5,5cm	Ugaoni  55/40/5	46/33/5,5cm 
--	---	--	---	---

RADIJALNI IVIČNJIACI

 11/20/40	 25/50 d=6,7,8,10cm	UGAONI IZAZONSKI IVIČNJIACI  7/21/80cm
---	---	--

URBANI MOBILIJAR

Betonske kante:

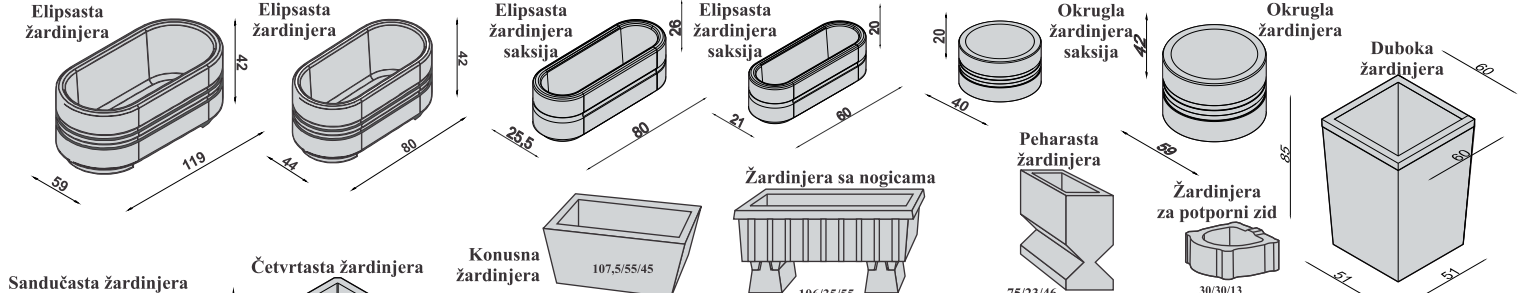
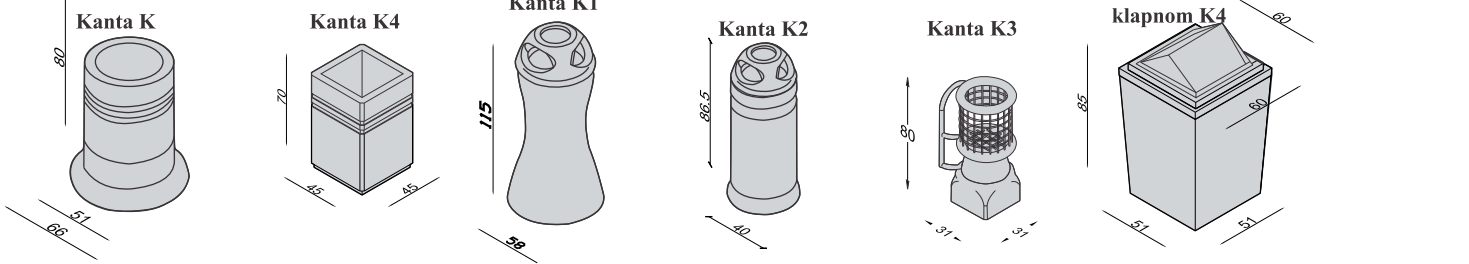

Klupe:

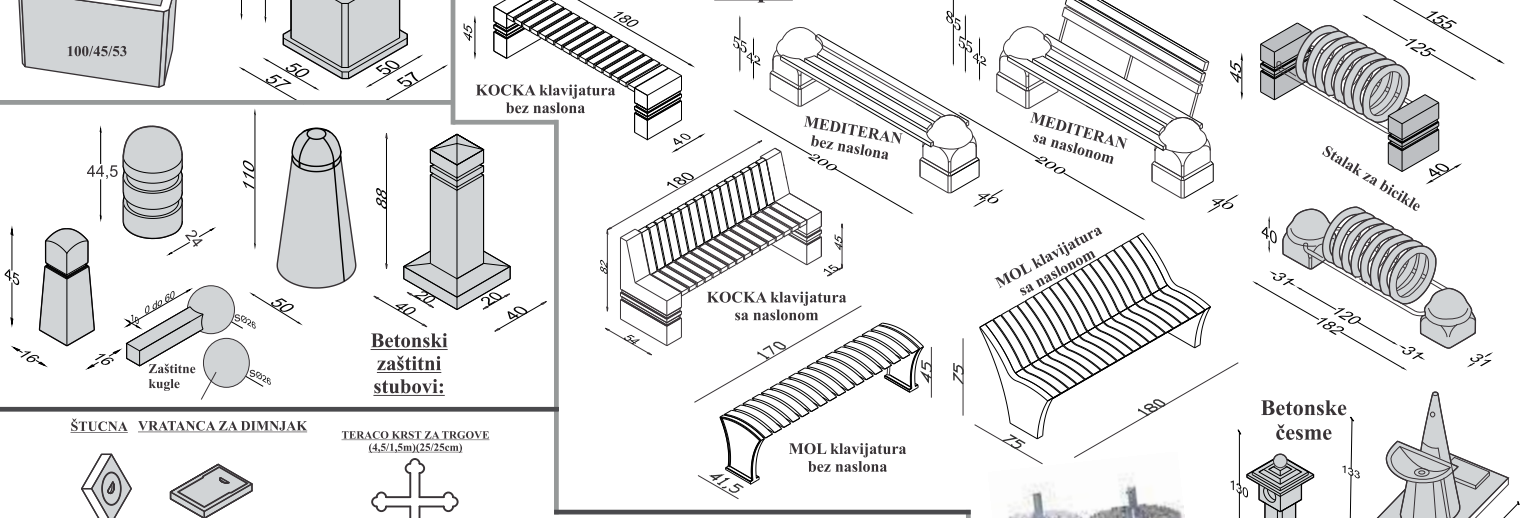

Betonski zaštitni stubovi:

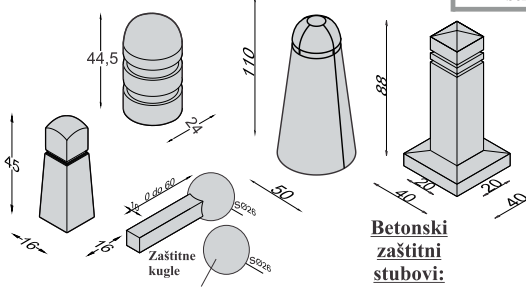

ŠTUCNA VRATANCA ZA DIMNJAK

TERAČO KRST ZA TRGOVE (4,5/1,5m)(25/25cm)

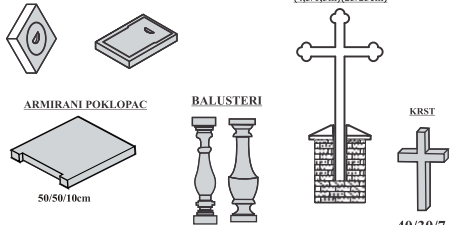

PROGRAM ZA OGRADE

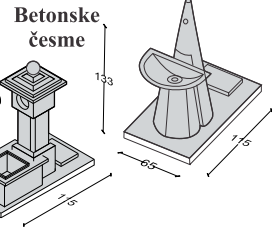
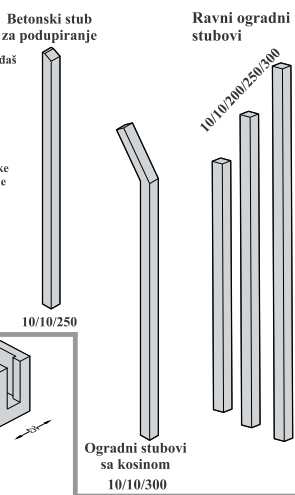
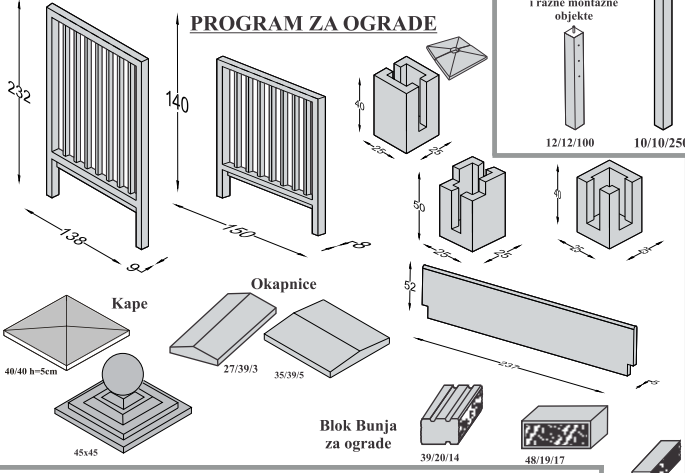

Blokovska roba:

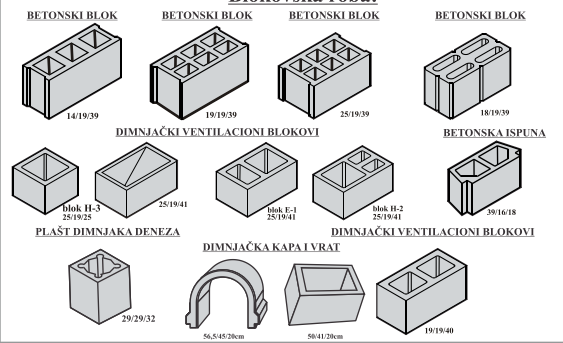

ELEMENTI BETON-GUMA

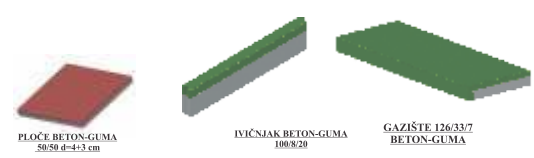

Elementi beton-guma namenjeni za privatne objekte, dečija igrališta, vrtiće, sportske terene, bolnice... Prednosti beton guma obloga: elastične sa potrebnom čvrstoćom, nisu toksične, otporne na habanje, ne klize,



● Centrala
● Izložbeno/prodajna mesta

Tiha

www.tiha-beton.rs
office@tiha-beton.rs
doo.tiha@gmail.com

**Pogon I
NOVI SAD
(SREMSKA KAMENICA)**
Sonje Marinković 2a
Telefon: +381 21 464 174
Fax: +381 21 462 255
Mobilni: +381 62 6000 64

**Pogon II
BEOGRAD
(PEĆINCI)**
Školska 53
Fax: +381 21 462 255
Mobilni: +381 62 6000 64

KONTAKT

PRIRODNI KAMEN ZA EKSTERIJER I ENTERIJER

Veliki izbor prirodnog kamena za uređenje enterijera i eksterijera. Prirodni kamen iz Srbije za fasade, stepeništa, unutrašnje zidove, kamine, ograde...





1



office@tiha-beton.rs
www.tiha-beton.rs
tel/fax: +381 21 462 255
mob: +381 62 6000 64



7



2



3



4



5



6



8



9



10



11



12



13



14



15



16





Dekorativni kamen sa efektom prirodnog kamena za dekoraciju eksterijera i enterijera

SREMSKA KAMENICA
Tiha
021/462-255
office@tiha-beton.rs



**Za Vaš vrt i toplinu Vašeg doma: prirodni kamen, behaton ploče, ivičnjaci, kanalice
urbani mobilijar (žardinjere, klupe, korpe, zaštitni stubovi), bazenski rubni kamen,
dekorativni kamen, roštilji, kamini...**

CENTRALA



Sonje Marinković 2
Sremska Kamenica
Republika Srbija
tel/fax: 021/462-255
021/464-174
www.tiha-beton.rs
office@tiha-beton.rs

PRODAJNI
SALONI

BEOGRAD

B&M MIŠIĆ
Bul.Kralja
Aleksandra 543 b
011/2895-945
063/6008-77

KIKINDA

DOO JOLIĆ CO
Bašaidski drum bb
0230/442-003
0230/24-778

BAČKI
PETROVAC

STR KOČKA
Kolarova 14
021/781-663

STARA
MORAVICA

SERTANIA DOO
Telefonska 2
064/706-00-22

VETERNIK

ARION DOO
Dragoslava
Srejovića 46
021/824-700

LEDINCI

STR ZORANOVIĆ
Dunavska bb
064/671-0060